

- ASHTON ACCOYA
- ASHTON RECYCLED PLASTIC
- ASHTON IPE

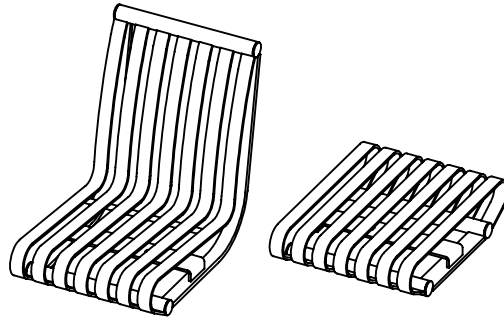

- CARNIVAL VERTICAL STRAP

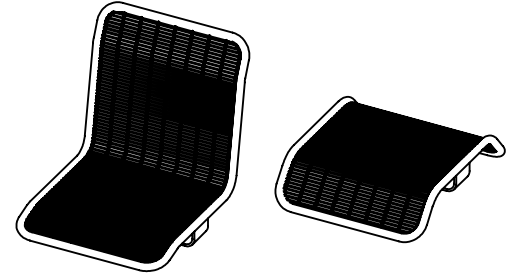

- CUNNINGHAM WIRE MESH

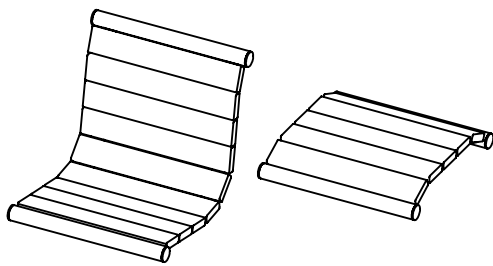

- GRAMERCY ACCOYA
- GRAMERCY RECYCLED PLASTIC
- GRAMERCY IPE

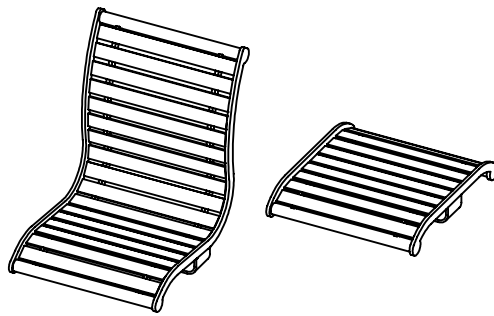

- LANGDON HORIZONTAL STRAP

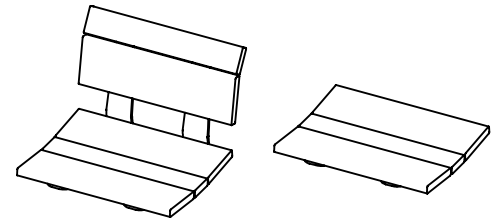

- LOFTY ACCOYA
- LOFTY IPE

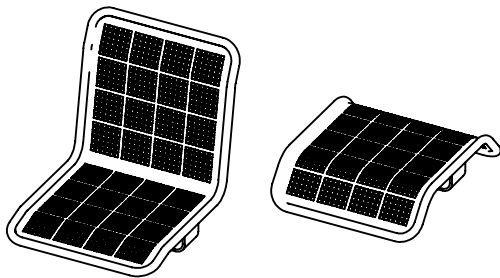

- STATE STREET PERFORATED

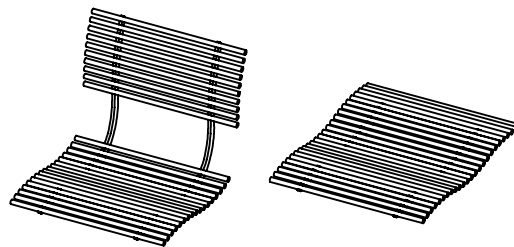

- VOLARE ROD

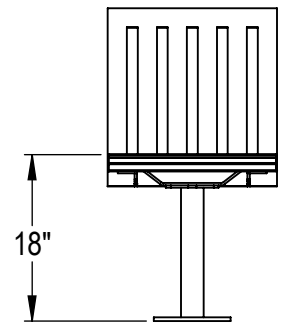

SEAT OPTION:

- BACKED
- FLAT

PRODUCT: SD-SFI
DESCRIPTION: INDIVIDUAL DINING HEIGHT TABLE
SURFACE FLANGE

DATE: 7-21-16
ENG: SMC

CONFIDENTIAL DRAWING AND INFORMATION IS NOT TO BE COPIED OR DISCLOSED TO OTHERS WITHOUT THE CONSENT OF GRABER MANUFACTURING, INC. SPECIFICATIONS ARE SUBJECT TO CHANGE WITHOUT NOTICE.

©2016 GRABER MANUFACTURING, INC. ALL PROPRIETARY RIGHTS RESERVED.

SOME ASSEMBLY REQUIRED

ASHTON SEAT SHOWN

SITE FURNISHING IS POWDER COATED WITH TGIC POLYESTER. STEEL SURFACE PREP INCLUDES MECHANICAL AND CHEMICAL ETCHING FOLLOWED WITH A COATING TO IMPROVE ADHESION AND CORROSION RESISTANCE.