

HEAVY DUTY SQUARE LINER

STAINLESS STEEL
LEVELING FEET

1/4" X 2" STEEL BAR

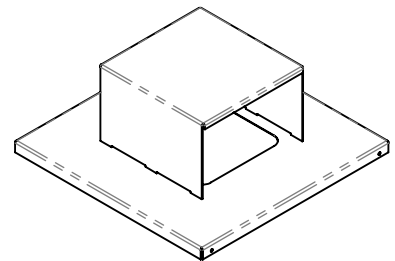
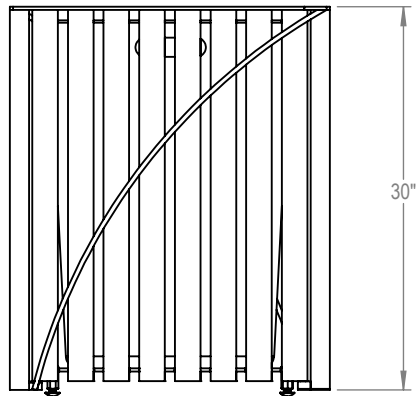
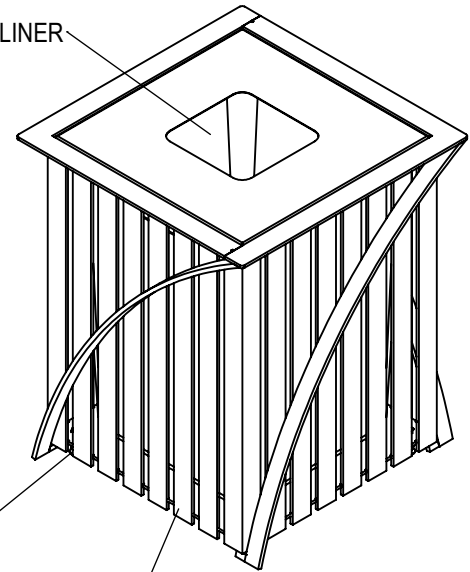

COVERED SQUARE LID

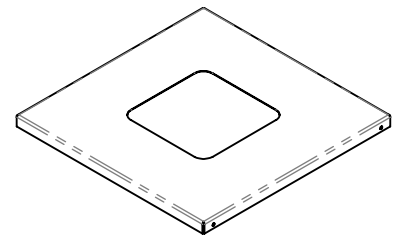

FLAT SQUARE LID

PRODUCT: ASTR-32
DESCRIPTION: ASHTON WASTE RECEPTACLE,
32 GALLON

DATE: 3-23-15
ENG: SMC

CONFIDENTIAL DRAWING AND INFORMATION IS NOT TO BE COPIED OR DISCLOSED
TO OTHERS WITHOUT THE CONSENT OF GRABER MANUFACTURING, INC.
SPECIFICATIONS ARE SUBJECT TO CHANGE WITHOUT NOTICE.

SITE FURNISHING IS POWDER COATED WITH TGIC POLYESTER.
STEEL SURFACE PREP INCLUDES MECHANICAL AND CHEMICAL
ETCHING FOLLOWED WITH A COATING TO IMPROVE ADHESION
AND CORROSION RESISTANCE.